

KWC-No. USGRS Sanitas Troesch

12.151.893.000FL
chromeline, A 155, tubi flessibili di collegamento, con piletta

12.151.093.000FL
chromeline, A 155, tubi flessibili di collegamento, senza piletta

Miscelatore a leva ■ Lavabo ■ Classe di efficienza B

- Miscelatore a leva
- Per lavabo sopra piano
 - Bocca fissa
 - Neoperl® Caché®
 - KWC cartuccia M 35
 - con tecnica a dischi in ceramica
 - regolazione continua della portata e della temperatura
 - limitazione della temperatura
 - Tubi flessibili di collegamento 3/8"
 - Fissaggio tramite raccordo filettato M33 x 1.5
 - Foratura ø35 mm

Portata 7.5 l/min (3 bar)
Classe di silenziosità per la rubinetteria I

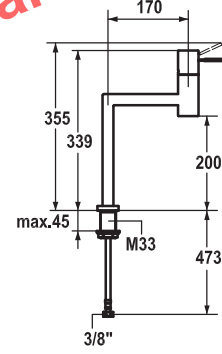
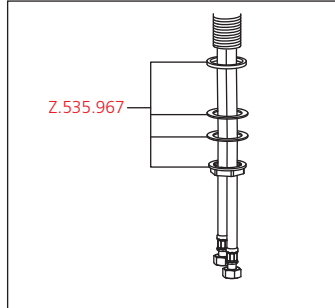
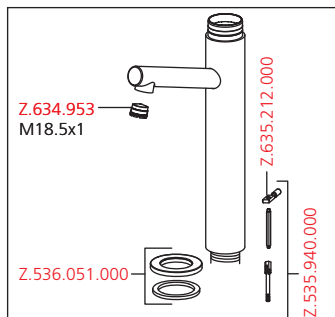
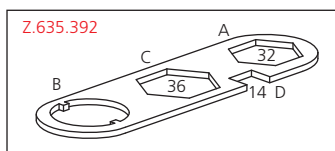
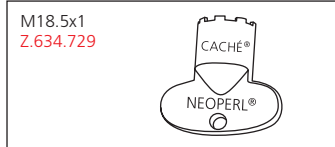
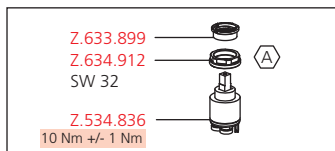
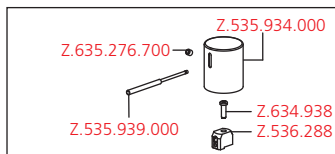

KWC-No. USGRS Sanitas Troesch

12.151.293.000FL
chromeline, A 170, tubi flessibili di collegamento, senza piletta

Miscelatore a leva ■ Lavabo ■ Classe di efficienza B

- Miscelatore a leva
- Per lavabo sopra piano
 - Bocca fissa
 - Neoperl® Caché®
 - KWC cartuccia M 35
 - con tecnica a dischi in ceramica
 - regolazione continua della portata e della temperatura
 - limitazione della temperatura
 - Tubi flessibili di collegamento 3/8"
 - Fissaggio tramite raccordo filettato M33 x 1.5
 - Foratura ø35 mm

Portata 7 l/min (3 bar)
Classe di silenziosità per la rubinetteria I

